

Data Sheet

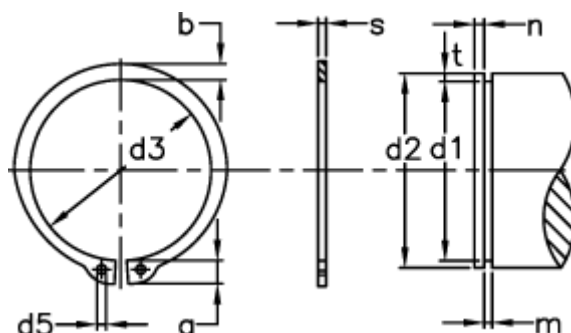

Article number: 0109047
 Description: Retaining ring AS 30x2.0
 Spring steel
 Note: Fitted with ZGA pliers

Measures



a max	= 6.5	Description	= AS 30	s	= 2.00
AN mm ²	= 64.4	FN kN	= 10.70	t	= 0.70
B	= 1.78	FRg kN	= 13.6	tol	= -0.21
b	= 4.1	FR kN	= 57.0	tol	= -0.07
d1	= 28.6	g	= 1.5	tol	= +0,21 -0,42
d2	= 30	m min	= 2.15	Tong	= ZGA-2
d3	= 27.9	n abl x 1000	= 21	Weight kg/1000	= 5.00
d5 min	= 2.0	Nominal drive	= 2.1		